

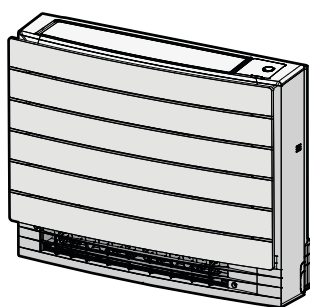

Operation manual

Split system air conditioners



CVXM20A2V1B
FVXM25A2V1B
FVXM35A2V1B
FVXM50A2V1B

Operation manual
Split system air conditioners

English

Table of Contents

1	About the documentation	2
1.1	About this document.....	2
2	User safety instructions	2
2.1	General.....	2
2.2	Instructions for safe operation.....	3
3	About the system	5
3.1	Indoor unit.....	5
3.1.1	Daikin eye indication lamp.....	5
3.2	About the user interface.....	5
3.2.1	Components: User interface.....	6
4	Before operation	6
4.1	To turn on the power supply.....	6
4.2	To insert the batteries.....	6
4.3	To mount the user interface holder.....	6
4.4	To set the clock.....	6
4.5	To set the brightness of the indoor unit display.....	7
5	Operation	7
5.1	Operation range.....	7
5.2	Operation mode and temperature setpoint.....	7
5.2.1	To start/stop operation mode and to set the temperature.....	7
5.3	Airflow rate.....	8
5.3.1	To adjust the airflow rate.....	8
5.4	Airflow direction.....	8
5.4.1	To adjust vertical airflow direction.....	8
5.4.2	To adjust the louvers (vertical blades).....	8
5.5	Air outlet selection.....	8
5.5.1	To set automatic air outlet selection or top air outlet only.....	9
5.6	Floor warming operation.....	9
5.6.1	To start/stop Floor warming operation.....	9
5.7	Powerful and Heat plus operation.....	9
5.7.1	Powerful operation.....	9
5.7.2	Heat plus operation.....	9
5.7.3	To start/stop Powerful and Heat plus operation.....	10
5.8	Econo and Outdoor unit quiet operation.....	10
5.8.1	Econo operation.....	10
5.8.2	Outdoor unit quiet operation.....	10
5.8.3	To start/stop Econo and Outdoor unit quiet operation.....	10
5.9	Flash Streamer (air cleaning) operation.....	10
5.9.1	To start/stop Flash Streamer (air cleaning) operation.....	10
5.10	OFF/ON timer operation.....	11
5.10.1	24 hour clock OFF/ON timer setting.....	11
5.10.2	12 hour countdown OFF/ON timer setting.....	11
5.11	Weekly timer operation.....	12
5.11.1	To set Weekly timer operation.....	12
5.11.2	To copy reservations.....	13
5.11.3	To confirm reservations.....	13
5.11.4	To deactivate and reactivate Weekly timer operation.....	13
5.11.5	To delete reservations.....	13
5.12	Wireless LAN connection.....	14
5.12.1	Precautions when using the wireless LAN.....	14
5.12.2	To install the Daikin Residential Controller application.....	14
5.12.3	To set the wireless connection.....	14
6	Energy saving and optimum operation	15
7	Maintenance and service	16
7.1	Overview: Maintenance and service.....	16
7.2	To clean the indoor unit and user interface.....	16
7.3	To clean the front panel.....	17
7.4	To remove the filters.....	17

7.5	To clean the air filter.....	17
7.6	To clean the titanium apatite deodorising filter.....	17
7.7	To replace the titanium apatite deodorising filter.....	18
7.8	To reinstall the filters.....	18
7.9	To re-install the front panel.....	18

8	Troubleshooting	18
9	Disposal	19

1 About the documentation

1.1 About this document

Thank you for purchasing this product. Please:

- Keep the documentation for future reference.

Target audience

End users



INFORMATION

This appliance is intended to be used by expert or trained users in shops, in light industry, and on farms, or for commercial and household use by lay persons.

Documentation set

This document is part of a documentation set. The complete set consists of:

- **General safety precautions:**
 - Safety instructions that you must read before operating your system
 - Format: Paper (in the box of the indoor unit)
- **Operation manual:**
 - Quick guide for basic usage
 - Format: Paper (in the box of the indoor unit)
- **User reference guide:**
 - Detailed step-by-step instructions and background information for basic and advanced usage
 - Format: Digital files on <http://www.daikineurope.com/support-and-manuals/product-information/>

Latest revisions of the supplied documentation may be available on the regional Daikin website or via your installer.

The original documentation is written in English. All other languages are translations.

2 User safety instructions

Always observe the following safety instructions and regulations.

2.1 General



WARNING

If you are NOT sure how to operate the unit, contact your installer.



WARNING

Children aged from 8 years and above and persons with reduced physical, sensory or mental capabilities or lack

of experience and knowledge can only use this appliance if they have been given supervision or instruction concerning the use of the appliance by a person responsible for their safety.

Children **MUST NOT** play with the appliance.

Cleaning and user maintenance **MUST NOT** be carried out by children without supervision.

WARNING

To prevent electrical shocks or fire:

- Do **NOT** rinse the unit.
- Do **NOT** operate the unit with wet hands.
- Do **NOT** place any objects containing water on the unit.

CAUTION

- Do **NOT** place any objects or equipment on top of the unit.
- Do **NOT** sit, climb or stand on the unit.

- Units are marked with the following symbol:



This means that electrical and electronic products may **NOT** be mixed with unsorted household waste. Do **NOT** try to dismantle the system yourself: the dismantling of the system, treatment of the refrigerant, of oil and of other parts must be done by an authorized installer and must comply with applicable legislation.

Units must be treated at a specialized treatment facility for reuse, recycling and recovery. By ensuring this product is disposed of correctly, you will help to prevent potential negative consequences for the environment and human health. For more information, contact your installer or local authority.

- Batteries are marked with the following symbol:



This means that the batteries may **NOT** be mixed with unsorted household waste. If a chemical symbol is printed beneath the symbol, this chemical symbol means that the battery contains a heavy metal above a certain concentration.

Possible chemical symbols are: Pb: lead (>0.004%).

Waste batteries must be treated at a specialized treatment facility for reuse. By ensuring waste batteries are disposed of correctly, you will help to prevent potential negative consequences for the environment and human health.

2.2 Instructions for safe operation



WARNING: MILDLY FLAMMABLE MATERIAL

The refrigerant inside this unit is mildly flammable.



CAUTION

The indoor unit contains radio equipment; the minimum separation distance between the radiating part of the equipment and the user is 30 cm.



CAUTION

Do **NOT** insert fingers, rods or other objects into the air inlet or outlet. When the fan is rotating at high speed, it will cause injury.



WARNING

- Do **NOT** modify, disassemble, remove, reinstall or repair the unit yourself as incorrect dismantling or installation may cause an electric shock or fire. Contact your dealer.
- In case of accidental refrigerant leaks, make sure there are no naked flames. The refrigerant itself is entirely safe, non-toxic and mildly flammable, but it will generate toxic gas when it accidentally leaks into a room where combustible air from fan heaters, gas cookers, etc. is present. Always have qualified service personnel confirm that the point of leakage has been repaired or corrected before resuming operation.



CAUTION

- **ALWAYS** use a user interface to adjust the angle of the flap. When the flap is swinging and you move it forcibly by hand, the mechanism will break.
- Be careful when adjusting the louvers. Inside the air outlet, a fan is rotating at high speed.



CAUTION

NEVER expose little children, plants or animals directly to the airflow.

2 User safety instructions

WARNING

Do NOT place objects below the indoor and/or outdoor unit that may get wet. Otherwise condensation on the unit or refrigerant pipes, air filter dirt or drain blockage may cause dripping, and objects under the unit may get dirty or damaged.

WARNING

Do NOT place a flammable spray bottle near the air conditioner and do NOT use sprays near the unit. Doing so may result in a fire.

CAUTION

Do NOT operate the system when using a room fumigation-type insecticide. Chemicals could collect in the unit, and endanger the health of people who are hypersensitive to chemicals.

WARNING

The refrigerant inside the unit is mildly flammable, but normally does NOT leak. If the refrigerant leaks in the room and comes in contact with fire from a burner, a heater, or a cooker, this may result in fire, or the formation of a harmful gas.

Turn off any combustible heating devices, ventilate the room, and contact the dealer where you purchased the unit.

Do NOT use the unit until a service person confirms that the part from which the refrigerant leaked has been repaired.

WARNING

- Do NOT pierce or burn refrigerant cycle parts.
- Do NOT use cleaning materials or means to accelerate the defrosting process other than those recommended by the manufacturer.
- Be aware that the refrigerant inside the system is odourless.

WARNING

The appliance shall be stored in a room without continuously operating ignition sources (example: open flames, an operating gas appliance or an operating electric heater).

DANGER: RISK OF ELECTROCUTION

To clean the air conditioner or air filter, be sure to stop operation and turn all power supplies off. Otherwise, an electric shock and injury may result.

WARNING

To prevent electrical shocks or fire:

- Do NOT rinse the unit.
- Do NOT operate the unit with wet hands.
- Do NOT place any objects containing water on the unit.

CAUTION

After a long use, check the unit stand and fitting for damage. If damaged, the unit may fall and result in injury.

WARNING

Improper detergents or cleaning procedure may cause damage on plastic components or water leakage. Splashed detergent on electric components, such as motors, may cause failure, smoke or ignition.

DANGER: RISK OF ELECTROCUTION

Before cleaning, be sure to stop the operation, turn the breaker off or pull out the supply cord. Otherwise, an electric shock and injury may result.

WARNING

Do NOT let the indoor unit get wet.
Possible consequence: Electric shock or fire.

CAUTION

Be careful when opening and handling the front panel; sharp edge of the front panel may cause injury.

WARNING

Stop operation and shut off the power if anything unusual occurs (burning smells etc.).

Leaving the unit running under such circumstances may cause breakage, electric shock or fire. Contact your dealer.

3 About the system

WARNING: MILDLY FLAMMABLE MATERIAL

The refrigerant inside this unit is mildly flammable.

CAUTION

The indoor unit contains radio equipment; the minimum separation distance between the radiating part of the equipment and the user is 30 cm.

NOTICE

Do NOT use the system for other purposes. In order to avoid any quality deterioration, do NOT use the unit for cooling precision instruments, food, plants, animals, or works of art.

3.1 Indoor unit

CAUTION

Do NOT insert fingers, rods or other objects into the air inlet or outlet. When the fan is rotating at high speed, it will cause injury.

INFORMATION

The sound pressure level is less than 70 dBA.

WARNING

- Do NOT modify, disassemble, remove, reinstall or repair the unit yourself as incorrect dismantling or installation may cause an electric shock or fire. Contact your dealer.
- In case of accidental refrigerant leaks, make sure there are no naked flames. The refrigerant itself is entirely safe, non-toxic and mildly flammable, but it will generate toxic gas when it accidentally leaks into a room where combustible air from fan heaters, gas cookers, etc. is present. Always have qualified service personnel confirm that the point of leakage has been repaired or corrected before resuming operation.

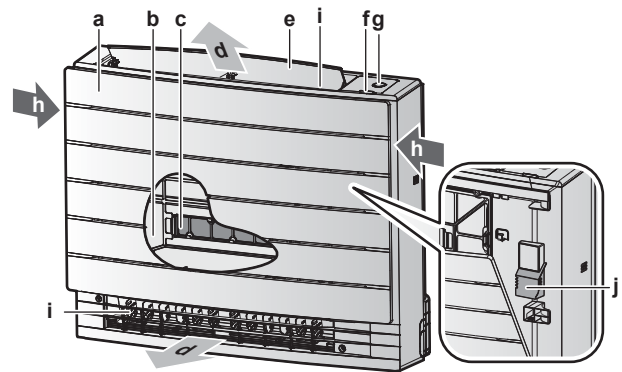

- a Front panel
- b Air filter
- c 2× titanium apatite deodorising filter
- d Air outlet
- e Flap (horizontal blade)
- f Signal receiver for user interface
- g ON/OFF button, Daikin eye and timer lamp
- h Air inlet
- i Louvers (vertical blades)
- j Room temperature sensor

ON/OFF button

If the user interface is missing, you can use the ON/OFF button on the indoor unit to start/stop operation. When operation is started using this button, the following settings are used:

- Operation mode = Automatic
- Temperature setting = 25°C
- Airflow rate = Automatic

3.1.1 Daikin eye indication lamp

Daikin eye color will change according to operation.

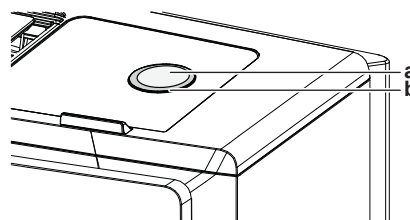

- a ON/OFF button
- b Daikin eye

Operation	Daikin eye color
Automatic	Red/blue
Drying	Green
Cooling	Blue
Heating	Red
Fan only	White
Timer operation	Orange ^(a)

^(a) When the OFF/ON timer or Weekly timer operation is set, the Daikin eye periodically changes to orange. After lighting orange for about 10 seconds, it returns to the colour of the operation mode for 3 minutes. **Example:** When the timer is set during cooling operation, the Daikin eye will periodically light orange for 10 seconds, and then switch to blue for 3 minutes.

3.2 About the user interface

- Direct sunlight.** Do NOT expose the user interface to direct sunlight.
- Dust.** Dust on the signal transmitter or receiver will reduce sensitivity. Wipe off dust with a soft cloth.

4 Before operation

- **Fluorescent lights.** Signal communication might be disabled if fluorescent lamps are in the room. In that case, contact your installer.
- **Other appliances.** If the user interface signals operate other appliances, move the other appliances, or contact your installer.
- **Curtains.** Make sure that the signal between the unit and the user interface is NOT blocked by curtains or other objects.

NOTICE

- Do NOT drop the user interface.
- Do NOT let the user interface get wet.

3.2.1 Components: User interface

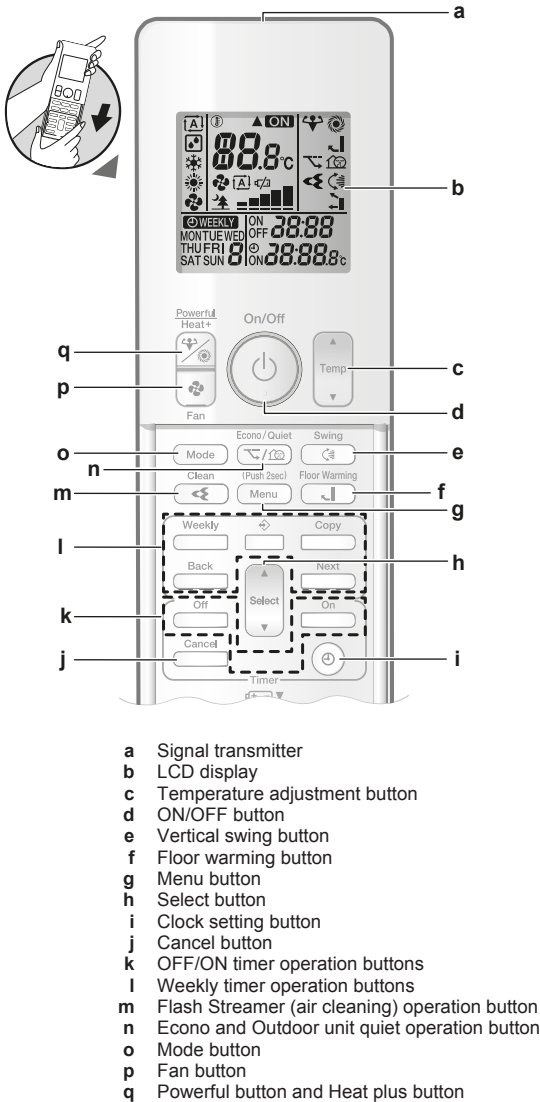

- Put back the front cover.

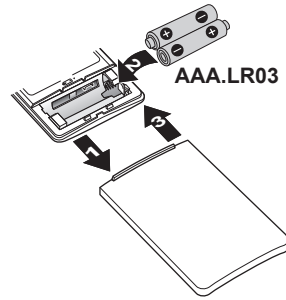

INFORMATION

- Low energy of battery is indicated by icon on the LCD display.
- ALWAYS replace both batteries together.

4.3 To mount the user interface holder

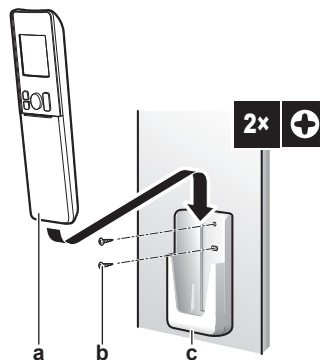

- a User interface
- b Screws (field supply)
- c User interface holder

- Choose a place where the signal can reach the unit.
- Fix the user interface holder (accessory) to the wall or a similar location using 2 M3×20L screws (field supply).
- Insert the user interface into the user interface holder.

4.4 To set the clock

Note: If the time is NOT set, MON, ☉, and 0:00 blink.

- Press .

Result: MON and ☉ blink

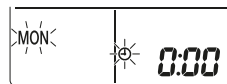

- Press or to set the current day of the week.

- Press .

Result: ☉ blinks.

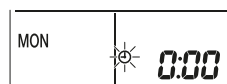

- Press or to set the correct time.

Note: Holding down or increases or decreases the time setting rapidly.

- Press .

Result: Setting is complete. . blinks.

4 Before operation

4.1 To turn on the power supply

- Turn the circuit breaker on.

4.2 To insert the batteries

The batteries will last for about 1 year.

- Remove the front cover.
- Insert both batteries at once.



4.5 To set the brightness of the indoor unit display

- 1 On the home screen, press **Menu** for at least 2 seconds.

Result: The selection menu number 1 appears on the display. 1 is blinking.

- 2 Press **Menu** to enter the setting.

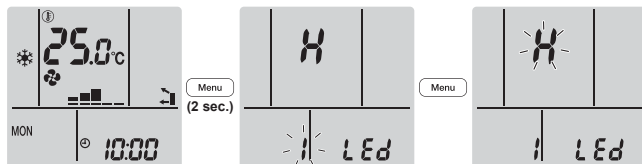

- 3 Press **Select** or **Select** to change the setting as follows:



Blinking	Brightness
H	High
L	Low
of	Off

- 4 Press **Menu** to confirm the selected setting.

Result: The brightness setting is changed.

Note: The display automatically returns to the default screen after 60 seconds. To return to the default screen sooner, press **Cancel** twice.

5 Operation

5.1 Operation range

Use the system in the following temperature and humidity ranges for safe and effective operation.

In combination with outdoor unit RXM25~50, 2MXM40+50, 3MXM40+52		
	Cooling and drying ^{(a)(b)}	Heating ^(a)
Outdoor temperature	-10~46°C DB	-15~24°C DB -15~18°C WB
Indoor temperature	18~32°C DB 14~23°C WB	10~30°C DB
Indoor humidity	≤80% ^(b)	—

^(a) A safety device might stop the operation of the system if the unit runs outside its operation range.

^(b) Condensation and water dripping might occur if the unit runs outside its operation range.

In combination with outdoor unit RXTP25+35		
	Cooling and drying ^{(a)(b)}	Heating ^(a)
Outdoor temperature	-10~46°C DB	-25~24°C DB -25~18°C WB
Indoor temperature	18~32°C DB 14~23°C WB	10~30°C DB

In combination with outdoor unit RXTP25+35		
	Cooling and drying ^{(a)(b)}	Heating ^(a)
Indoor humidity	≤80% ^(b)	—

^(a) A safety device might stop the operation of the system if the unit runs outside its operation range.

^(b) Condensation and water dripping might occur if the unit runs outside its operation range.

5.2 Operation mode and temperature setpoint

When. Adjust the system operation mode and set the temperature when you want to:

- Heat up or cool down a room
- Blow air in a room without heating or cooling
- Decrease the humidity in a room

What. The system operates differently, depending on the user selection.

Setting	Description
A Automatic	The system cools down or heats up a room to the temperature setpoint. It automatically switches between cooling and heating if necessary.
D Drying	The system decreases the humidity in a room.
H Heating	The system heats up a room to the temperature setpoint.
C Cooling	The system cools down a room to the temperature setpoint.
F Fan	The system only controls the airflow (airflow rate and airflow direction). The system does NOT control the temperature.

Additional info:

- **Outside temperature.** The system's cooling or heating effect decreases when the outside temperature is too high or too low.
- **Defrost operation.** During heating operation, frost might occur on the outdoor unit and decrease the heating capacity. In that case, the system automatically switches to defrosting operation to remove the frost. During defrosting operation, hot air is NOT blown from the indoor unit.

5.2.1 To start/stop operation mode and to set the temperature

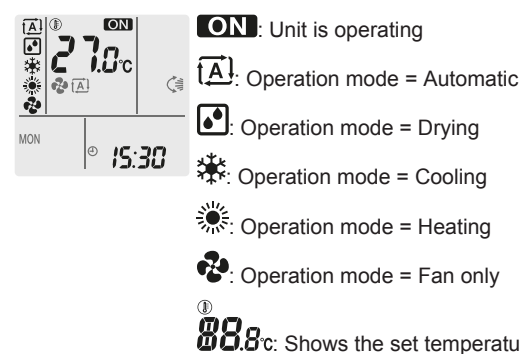

- 1 Press **Mode** one or more times to select the operation mode.

Result: The mode will be set as follows:



5 Operation

- 2 Press to **start** operation.

Result: **ON** is displayed on the LCD. The Daikin eye indication lamp changes colour according to the operation. See "Daikin eye indication lamp" [▶ 5].

- 3 Press or one or more times to lower or raise the **temperature**.

Cooling operation	Heating operation	Automatic operation	Drying or Fan only operation
18~32°C	10~30°C	18~30°C	—

Note: When using **drying** or **fan only** mode, you cannot adjust the temperature.

- 4 Press to **stop** operation.

Result: **ON** disappears from the LCD. The Daikin eye indication lamp goes off.

5.3 Airflow rate

- 1 Press to choose:

	5 airflow rate levels, from "—" to "■"
	Automatic airflow rate operation
	Indoor unit quiet operation. When the airflow rate is set to "▲", the noise from the unit will be reduced.

INFORMATION

- If the unit reaches the temperature setpoint in cooling or heating mode, the fan will stop operating.
- When using drying operation mode, you CANNOT adjust the airflow rate setting.
- The airflow rate in the automatic airflow rate operation is set according to the room temperature; in some cases it may be lower than in the indoor unit quiet operation and if the airflow rate is changed to the indoor unit quiet operation at this time, the operating noise may become higher.

5.3.1 To adjust the airflow rate

- 1 Press to change the airflow setting as follows:



5.4 Airflow direction

When. Adjust the airflow direction as desired.

What. The system directs the airflow differently, depending on the user selection.

Setting	Display	Airflow direction
Vertical auto swing		Swinging or fixed position of the horizontal blades (flaps).
Horizontal airflow		Position of the vertical blades (louvers) is set manually.

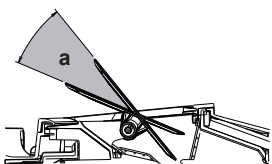

a Movable range of the flaps

CAUTION

- ALWAYS use a user interface to adjust the angle of the flap. When the flap is swinging and you move it forcibly by hand, the mechanism will break.
- Be careful when adjusting the louvers. Inside the air outlet, a fan is rotating at high speed.

INFORMATION

In vertical auto swing, the flaps will stop in up position if the air flow rate becomes weak.

5.4.1 To adjust vertical airflow direction

- 1 Press .

Result: appears on the LCD. The flaps (horizontal blades) will begin to swing.

- 2 To use fixed position, press when the flaps reach the desired position.

Result: disappears from the LCD. The flaps will stop moving.

5.4.2 To adjust the louvers (vertical blades)

- 1 Adjust horizontal blades using the user interface so you can easily access the knobs on the vertical blades.
- 2 Hold the knobs and move them up slightly.
- 3 Adjust left or right to the desired position while holding the knobs.

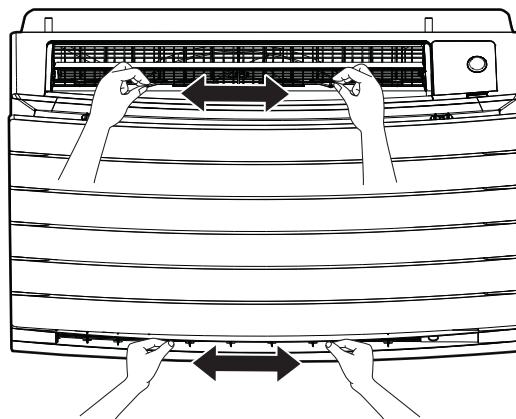



INFORMATION

When the unit is installed in a corner of a room, the direction of the louvers should be facing away from the wall. Efficiency will drop if a wall blocks the air.

5.5 Air outlet selection

Use this feature to let the unit decide automatically which air outlet should be used or set the top air outlet only. The default setting is automatic air outlet selection.

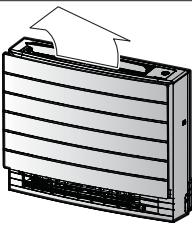
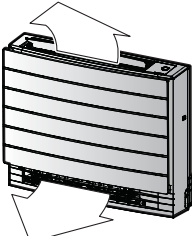
Setting	Display	Airflow direction
Automatic air outlet selection		The unit decides automatically the best air outlet depending on the operation mode or room conditions.
Top air outlet only		The airflow is set to top air outlet, regardless of the operation mode or room conditions.

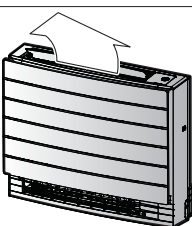
Setting	Operation mode	Situation	Air outlet selection
	Drying	Any situation	
	Cooling	When the room temperature reaches the setpoint or the total operation time at high humidity reaches 1 hour.	
	Heating, fan only	When the setpoint temperature is NOT reached yet, or the total operation time at high humidity is less than 1 hour.	
	Drying, cooling, heating, fan only	Any situation	

INFORMATION

- During drying operation the airflow comes from the top air outlet only. See "5.2 Operation mode and temperature setpoint" [▶ 7] for setting.
- During Floor warming operation, the airflow comes from the bottom air outlet only. See "5.6 Floor warming operation" [▶ 9] for setting. Floor warming can be set only with the automatic air outlet selection setting.
- If you change the setting from the automatic air outlet selection to the top air outlet only in the heating operation, heating is temporarily stopped to protect the unit.
- Cooling/heating ability is lower when the top air outlet only is set.
- While the air outlet selection is changing, a sound of the moving damper can be heard.

5.5.1 To set automatic air outlet selection or top air outlet only

Prerequisite: The default setting is automatic air outlet selection.

- On the home screen, press  for at least 2 seconds.

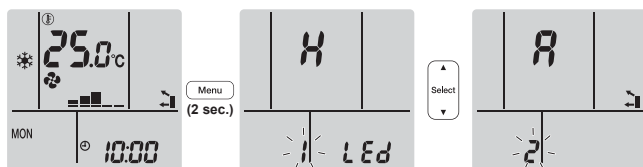

Result: The selection menu appears. The menu number is blinking.

- Press  or  to select menu number 2.



- Press  to enter the setting.

Result: "R" is blinking.

- Press  or  to change the setting. "R" = automatic air outlet selection or "I" = top air outlet only.

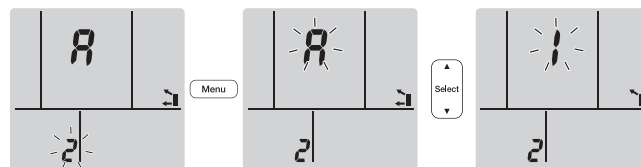

- Press  to confirm the selected setting.

Result: The setting is changed.

Note: The display automatically returns to the default screen after 1 minute. To return to the default screen sooner, press  twice.

5.6 Floor warming operation

This operation can effectively warm large floor areas by closing the top air outlet and increasing the air velocity to reach distant floor surfaces.

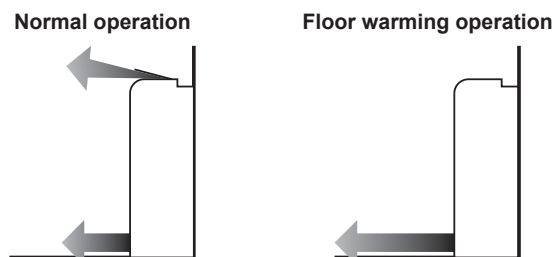

INFORMATION

- Floor warming operation can be used in heating operation mode only and with the automatic air outlet selection setting.
- If the room temperature is low, the room may not get warm enough.

5.6.1 To start/stop Floor warming operation

Prerequisite: This operation can be set only in heating operation mode and with the automatic air outlet selection setting.

- Press .

Result:  is displayed on the LCD and the operation starts.

- To stop operation, press .

Result:  disappears from the LCD and operation stops.

5.7 Powerful and Heat plus operation

5.7.1 Powerful operation

This operation quickly maximizes the cooling/heating effect in any operation mode. You can get the maximum capacity.

INFORMATION

- Powerful operation cannot be used together with Heat plus, Floor warming, Econo and Outdoor unit quiet operation. The last selected function takes priority.
- Powerful operation will NOT increase the capacity of the unit if it already operates at maximum capacity.

5.7.2 Heat plus operation

This operation increases the airflow temperature coming from the unit. The airflow temperature is higher than during the normal heating operation. Use this operation when you want to feel more warmth. This operation has a 30 minute duration.

5 Operation

INFORMATION



- Heat plus operation can be used in heating operation mode only.
- If the room temperature is low, the room may not get warm enough.
- Do NOT stay close to the air outlet in the direct path of discharged air for a long time.
- After the HEAT PLUS operation ends, depending on the temperature set for HEAT operation, the power may be temporarily reduced.
- In Multi system connection, the airflow temperature may be insufficient.

5.7.3 To start/stop Powerful and Heat plus operation

- Press  one or more times to select operation.



Result: The setting will change as follows.



Display	Operation
	Powerful
	Heat plus
—	Both deactivated

- Powerful operation runs for 20 minutes; after that, operation returns to the previously set mode.
- Heat plus operation runs for 30 minutes; after that, operation returns to the previously set mode.

- To stop operation, press  until both symbols disappear from the LCD.

Note: Powerful operation and Heat plus can be set only when the unit is running. If you press , operation will be cancelled;  and  disappear from the LCD.

5.8 Econo and Outdoor unit quiet operation

5.8.1 Econo operation

This is a function which enables efficient operation by limiting the maximum power consumption value. This function is useful for cases in which attention should be paid to ensure a circuit breaker will not trip when the product runs alongside other appliances.

INFORMATION

- Powerful, Heat plus, Floor warming and Econo operation CANNOT be used at the same time. The last selected function takes priority.
- Econo operation is only available in automatic, cooling, heating and drying operation modes.
- Econo operation reduces power consumption of the outdoor unit by limiting the rotation speed of the compressor. If power consumption is already low, Econo operation will NOT further reduce power consumption.

5.8.2 Outdoor unit quiet operation

Use Outdoor unit quiet operation when you want to decrease the noise level of the outdoor unit. **Example:** At night.

INFORMATION



- Powerful, Heat plus, Floor warming and Outdoor unit quiet operation CANNOT be used at the same time. The last selected function takes priority.
- Outdoor unit quiet operation is only available in automatic, cooling, and heating operation.
- Outdoor unit quiet operation limits the rotation speed of the compressor. If the rotation speed of compressor is already low, Outdoor unit quiet operation will NOT further reduce the compressor rotation speed.

5.8.3 To start/stop Econo and Outdoor unit quiet operation



- Press  one or more times.

Result: The setting will change as follows.



Display	Operation
	Econo
	Outdoor unit quiet
	Econo and Outdoor unit quiet
—	Both deactivated

- To stop operation, press  until both symbols disappear from the LCD.

Note: Econo operation can be only set when the unit is running. Pressing  cancels the setting and  disappears from the LCD.

Note:  remains on the LCD, even if you turn off the unit using the user interface or indoor unit ON/OFF switch.

5.9 Flash Streamer (air cleaning) operation

INFORMATION

- The high-speed electrons are generated and go away inside the unit to ensure safe operation.
- The Streamer discharge may generate a fizzing sound.
- If the airflow becomes weak, the Streamer discharge may stop temporarily to prevent ozone smell.

5.9.1 To start/stop Flash Streamer (air cleaning) operation

Prerequisite: Make sure the unit is operating (**ON** is displayed on the user interface LCD).

- Press .

Result:  is displayed on the LCD and the air in the room is cleaned when the unit is operating.

- To stop operation, press .

Result:  disappears from the LCD and operation stops.

i INFORMATION

- You can set the Flash Streamer operation when the unit is both ON or OFF, but operation starts only when the unit is operating.
- When the setting is done when the unit is NOT operating,  is displayed on the user interface LCD, but operation does NOT start.

5.10 OFF/ON timer operation

Timer functions are useful for automatically switching the air conditioner off/on at night or in the morning. You can also use OFF timer and ON timer in combination.

There are two types of OFF/ON timer setting:

- 24 hour clock OFF/ON timer** (default). The unit will stop/start operating at the set time. **Example:** The ON timer is set to 13:30, the unit will start operating at 13:30.
- 12 hour countdown OFF/ON timer.** The unit will stop/start operating after the set number of hours. **Example:** The ON timer is set at 10:30 to 3 hours, the unit will start operating at 13:30.

Note: It is possible to combine both timer setting types.

i INFORMATION

Program the timer again in case of:



- A breaker has turned the unit off.
- A power failure.
- After replacing batteries in the user interface.

i INFORMATION



The clock MUST be set correctly before using any timer functions. Refer to "4.4 To set the clock" [p 6].

5.10.1 24 hour clock OFF/ON timer setting**To start/stop OFF timer operation**

- Press  to start.

Result:  is displayed on the LCD and OFF blinks.  and the day of the week disappear from the LCD.





- Press  to change the time setting.
- Press  again.

Result: OFF and the set time are displayed on the LCD. The Daikin eye lights orange.

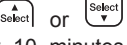
i INFORMATION



Each time  is pressed, the time setting advances by 10 minutes. Holding the button down will change the setting rapidly.

- To cancel the timer setting, press .



Result: The set time and OFF disappear from the LCD.  and the day of the week are displayed on the LCD. The Daikin eye stops lighting orange.

To start/stop ON timer operation

- Press  to start.

Result:  is displayed on the LCD and ON blinks.  and the day of the week disappear from the LCD.





- Press  to change the time setting.
- Press  again.

Result: ON and the set time are displayed on the LCD. The Daikin eye lights orange.

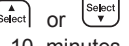
i INFORMATION

Each time  is pressed, the time setting advances by 10 minutes. Holding the button down will change the setting rapidly.

- To cancel the timer setting, press .

Result: The set time and ON disappear from the LCD.  and the day of the week are displayed on the LCD. The Daikin eye stops lighting orange.

To combine OFF timer and ON timer

- To set the timers, refer to "To start/stop OFF timer operation" [p 11] and "To start/stop ON timer operation" [p 11].

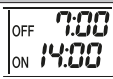

Result: OFF and ON are displayed on the LCD.

Example:



Display	Current time	Set while...	Operation
	6:00	the unit is operating.	Stops at 7:00 and starts at 14:00.
		the unit is NOT operating.	Starts at 14:00.



Note: If the timer setting is active, the current time is NOT displayed on the LCD.



5.10.2 12 hour countdown OFF/ON timer setting**To start/stop countdown OFF/ON timer operation**

- Press and hold  or  for about 5 seconds; when  blinks, release the button.

Result:

 For the OFF timer, *1hr* appears on the LCD and OFF blinks.  and the day of the week disappear from the LCD.

 For the ON timer, *1hr* appears on the LCD and ON blinks.  and the day of the week disappear from the LCD.

- Press  to change the time setting. The time can be set between 1~12 hours. Each pressing of the button increases or decreases the time setting by 1 hour.
- Press  or  to confirm the setting.

Result: OFF and/or ON and the set time are displayed on the LCD. The Daikin eye lights orange. The time displayed on the LCD will automatically count down by 1 hour for every hour that passes.

Example: If the OFF timer is set to 3 hours, the displayed time will change as follows: 3hr → 2hr → 1hr → blank (OFF)

- To change the setting back to 24 hour OFF/ON timer, repeat step 1 when on the home screen when OFF and/or ON are NOT blinking.
- To cancel the timer setting, press .

5 Operation

To combine the timer display modes

Different display modes (24 hour and 12 hour countdown OFF/ON timer) can be used for the OFF timer and ON timer simultaneously.

- For setting, see "To start/stop OFF timer operation" [▶ 11], "To start/stop ON timer operation" [▶ 11] and "To start/stop countdown OFF/ON timer operation" [▶ 11].

Example:

Display	Current time	Set while...	Operation
OFF 3hr ON 6:00	22:00	the unit is operating.	Stops at 1:00 (3 hours after present time)
OFF 1:00 ON 8hr			Starts at 6:00. (8 hours after present time)
OFF 3hr ON 8hr			

Note: If the timer setting is active, the current time is NOT displayed on the LCD.

5.11 Weekly timer operation

i INFORMATION

Do not use the Weekly timer setting simultaneously with the Daikin Residential Controller app schedule timer. Both settings are independent of each other. Use only one of them.

With this operation, you can save up to 4 timer settings for each day of the week.

Example: Create a different setting from Monday to Friday and a different setting for weekends.

Day of the week	Setting example
Monday • Make up to 4 settings.	
Tuesday~Friday • Use the copy mode if the settings are the same as for Monday.	
Saturday • No timer setting	—
Sunday • Make up to 4 settings.	

- ON-ON-ON-ON setting.** Enables scheduling the operation mode and set temperature.
- OFF-OFF-OFF-OFF setting.** Only the turn off time can be set for each day.

Note: Be sure to aim the user interface at the indoor unit and check for a receiving tone when setting the Weekly timer operation.

i INFORMATION

The clock **MUST** be set correctly before using any timer functions. Refer to "4.4 To set the clock" [▶ 6].

i INFORMATION

- Weekly timer and OFF/ON timer operation **CANNOT** be used at the same time. The OFF/ON timer operation takes priority. Weekly timer will be in standby, **WEEKLY** disappears from the LCD. When the OFF/ON timer is completed, the Weekly timer becomes active.
- The day of the week, OFF/ON timer mode, time and temperature (only for ON timer) can be set with the Weekly timer. Other settings are based on previous ON timer setting.

5.11.1 To set Weekly timer operation

- Press .

Result: The day of the week and the reservation number of the current day are displayed.



- Press or to select the day of the week and the reservation number.

- Press **Next**.

Result: The day of the week is set. **WEEKLY** and ON blink.



- Press or to select the mode.

Result: The setting will change as follows:



Display	Feature
ON	ON timer
OFF	OFF timer
Blank	Deletes reservation

- Press **Next**.

Result: The OFF/ON timer mode is set. **WEEKLY** and the time blink.



Note: Press **Back** to return to the previous screen. If blank is selected, continue to step 9.

- Press or to select the time. The time can be set between 0:00~23:50 in 10-minute intervals.

- Press **Next**.

Result: The time is set and **WEEKLY** and the temperature blink.



Note: Press **Back** to return to the previous screen. If OFF timer is selected, continue to step 9.

- Press or to select the desired temperature.

Note: The set temperature for the weekly timer is displayed only when setting the weekly timer mode.

i INFORMATION

The temperature can be set between 10~32°C on the user interface, however:

- in cooling and automatic operation mode, the unit will operate at minimum 18°C even if is set at 10~17°C;
- in heating and automatic operation mode, the unit will operate at maximum 30°C even if is set at 31~32°C.

9 Press **Next**.

Result: The temperature and time are set for the ON timer. The time is set for the OFF timer. The Daikin eye lights orange.

Result: A new reservation screen will appear.

10 Repeat the previous procedure to set another reservation or press **Exit** to complete the setting.

Result: **WEEKLY** is displayed on the LCD.

Note: A reservation can be copied with the same settings to another day. Refer to "To copy reservations" [p 13].

5.11.2 To copy reservations

A reservation can be copied to another day. The complete reservation of the selected day of the week will be copied.

- 1 Press **Exit**.
- 2 Press **Select** or **Select** to select the day of the week to be copied.
- 3 Press **Copy**.

Result: The reservation of the selected day of the week will be copied.

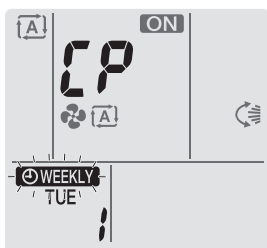

- 4 Press **Select** or **Select** to select the destination day.
- 5 Press **Copy**.

Result: The whole reservation is copied to the selected day and the Daikin eye lights orange.

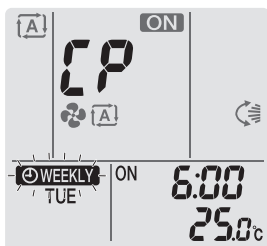

Note: To copy to another day, repeat the procedure.

- 6 Press **Exit** to complete the setting.

Result: **WEEKLY** is displayed on the LCD.

Note: To change the reservation setting after copying, refer to "To set Weekly timer operation" [p 12].

5.11.3 To confirm reservations

You can confirm if all reservations are set to your needs.

- 1 Press **Exit**.

Result: The day of the week and the reservation number of the current day are displayed.

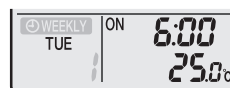

- 2 Press **Select** or **Select** to select the day of the week and reservation number to be confirmed and check the reservation details.

Note: To change the reservation setting, refer to "To set Weekly timer operation" [p 12].

- 3 Press **Exit** to exit the confirmation mode.

5.11.4 To deactivate and reactivate Weekly timer operation

- 1 To deactivate the Weekly timer, press **Weekly** while **WEEKLY** is displayed on the LCD.

Result: **WEEKLY** disappears from the LCD and the Daikin eye stops lighting orange.

- 2 To reactivate the Weekly timer, press **Weekly** again.

Result: The last set reservation mode will be used.

5.11.5 To delete reservations

To delete individual reservations

Use this function if you want to delete a single reservation setting.

- 1 Press **Exit**.
Result: The day of the week and the reservation number are displayed.
- 2 Press **Select** or **Select** to select the day of the week to be deleted.
- 3 Press **Next**.
Result: **WEEKLY**, ON, and OFF blink.
- 4 Press **Select** or **Select** and select "blank".

Result: The setting will change as follows:



- 5 Press **Next**.
Result: The selected reservation is deleted.
- 6 Press **Exit** to exit.

Result: Remaining reservations are active.

To delete a reservation for each day of the week

Use this function if you want to delete all reservation settings for one day of the week. This can be used in confirmation or setting mode.

- 1 Press **Exit**.
- 2 Press **Select** or **Select** to select the day of the week to be deleted.
- 3 Hold **Weekly** for about 5 seconds.

Result: All reservations for the selected day are deleted.

- 4 Press **Exit** to exit.

Result: Remaining reservations are active.

To delete all reservations

Use this function if you want to delete all reservations for all days of the week in one go. This procedure CANNOT be used in the setting mode.

- 1 Hold **Weekly** for about 5 seconds while in the default display.

Result: All reservations will be deleted.

5 Operation

5.12 Wireless LAN connection

The customer is responsible for providing:

- Smartphone or tablet with minimum supported version of Android or iOS, specified on <http://www.onlinecontroller.daikineurope.com>
- Internet line and communication device, such as a modem, router, etc.
- Wireless LAN access point
- Installed free Daikin Residential Controller application

5.12.1 Precautions when using the wireless LAN

Do NOT use near:

- Medical equipment.** E.g. persons using cardiac pacemakers or defibrillators. This product may cause electromagnetic interference.
- Auto-control equipment.** E.g. automatic doors or fire alarm equipment. This product may cause faulty behaviour of the equipment.
- Microwave oven.** It may affect wireless LAN communications.

5.12.2 To install the Daikin Residential Controller application

- Open:
 - Google Play for appliances using Android.
 - App Store for appliances using iOS.
- Search for Daikin Residential Controller.
- Follow the directions on the screen to install.

5.12.3 To set the wireless connection

There are two options to connect the wireless adapter with your smart device.

- Connect the wireless LAN to your smart device directly.**
- Connect the wireless LAN to your home network.** The wireless LAN will communicate with your smart device in your home network using a modem, router or a similar device.

For more information and FAQ refer to:

<http://www.onlinecontroller.daikineurope.com/>.

- Stop operation before setting the wireless connection.
- Use the user interface to select the wireless LAN setting menu.

Note: Always aim the user interface at the signal receiver on the unit when operating the user interface.

Menu	Description
!	Connection status check
2	WPS connection setting
3	AP mode/RUN mode (SSID + KEY) connection setting
R	Reset to factory default
oFF	Wireless LAN OFF

To confirm the wireless LAN connection status

- On the home screen, press  for at least 5 seconds while the unit is not operating.
Result: SP appears on the display. ! is blinking.

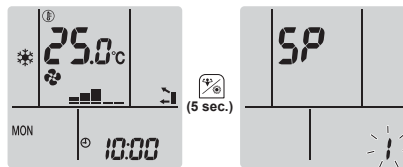

- Press  to confirm the selection.

Result: ! is blinking.

- Check the Daikin eye.

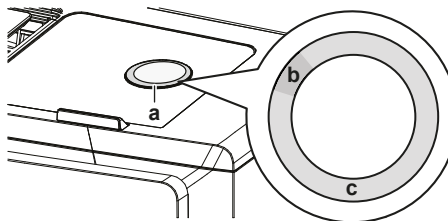

- a Daikin eye
- b Partly green
- c Red, orange, blue or white

Daikin eye colour alternates between partly green and...	...then wireless adapter is...
red	not connected
orange	running and ready to connect to the home network via WPS button; see "To connect using the WPS button" [▶ 14].
blue	<ul style="list-style-type: none"> connected to the home network via SSID + KEY. or <ul style="list-style-type: none"> connected to the home network via WPS button on the router.
white	off

- Press  to exit the menu.

Result: The display will return to the home screen.

To connect the wireless LAN to your home network

The wireless adapter can be connected to your home network using the:

- WPS button on the router (if present),
- SSID and KEY number located on the unit.

To connect using the WPS button

- On the home screen, press  for at least 5 seconds while the unit is not operating.

Result: SP appears on the display. ! is blinking.

- Press  to change the SP menu to 2.



- Press  to confirm the selection.

Result: 2 is blinking. The Daikin eye colour alternates between orange and partly green.

- Press the WPS button on your communication device (e.g. router) within approximately 1 minute. Refer to the manual of your communication device.

Result: If the connection was successful, the Daikin eye colour alternates between blue and partly green.

INFORMATION

If the connection with your router is not possible, try procedure "To connect using SSID and KEY number" [p. 15].

- Press **Cancel** to exit the menu.

Result: The display will return to the home screen.

To connect using SSID and KEY number

- On the home screen, press  for at least 5 seconds while the unit is not operating.

Result: SP appears on the display.  is blinking.

- Press  twice to change the SP menu to **3**.

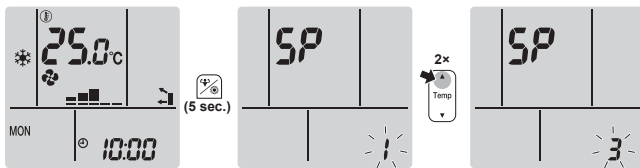

- Press  to confirm the selection.

Result: **3** is blinking. The Daikin eye colour alternates between red and partly green.

- Open the Daikin Residential Controller application on your smart device and follow the steps on the screen.

Result: If the connection was successful, the Daikin eye colour alternates between blue and partly green.

- Connect your smart device to the same home network as the unit.
- Press **Cancel** to exit the menu.

Result: The display will return to the home screen.

To reset the connection setting to the factory default

Reset the connection setting to the factory default in case you want to:

- disconnect the wireless LAN and the communication device (e.g. router) or smart device.
- repeat the setting if the connection was unsuccessful.

- On the home screen, press  for at least 5 seconds while the unit is not operating.

Result: SP appears on the display.  is blinking.

- Press  twice to change the SP menu to **R**.

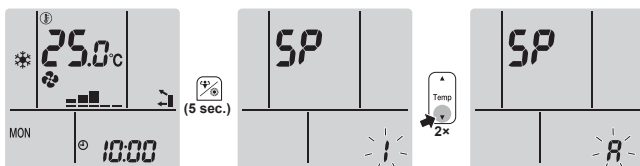

- Hold  for at least 2 seconds to confirm the selection.

Result: **R** is blinking. The setting is reset to the factory default.

- Press **Cancel** to exit the menu.

Result: The display will return to the home screen.

To turn off the wireless LAN connection

If you want to turn off the wireless connection function:

- On the home screen, press  for at least 5 seconds while the unit is not operating.

Result: SP appears on the display.  is blinking.

- Press  change the SP menu to **OFF**.

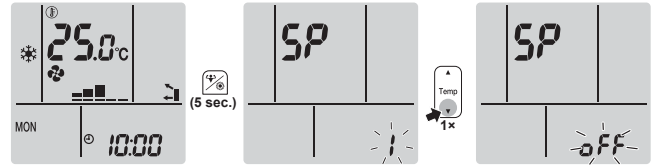

- Hold  for at least 2 seconds to confirm the selection.

Result: **OFF** is blinking. Communication is OFF.

- Press **Cancel** to exit the menu.

Result: The display will return to the home screen.

6 Energy saving and optimum operation

INFORMATION

- Even if the unit is turned OFF, it consumes electricity.
- When the power turns back on after a power break, the previously selected mode will be resumed.

CAUTION

NEVER expose little children, plants or animals directly to the airflow.

WARNING

Do NOT place objects below the indoor and/or outdoor unit that may get wet. Otherwise condensation on the unit or refrigerant pipes, air filter dirt or drain blockage may cause dripping, and objects under the unit may get dirty or damaged.

WARNING

Do NOT place a flammable spray bottle near the air conditioner and do NOT use sprays near the unit. Doing so may result in a fire.

CAUTION

Do NOT operate the system when using a room fumigation-type insecticide. Chemicals could collect in the unit, and endanger the health of people who are hypersensitive to chemicals.

Observe the following precautions to ensure the system operates properly.

- Prevent direct sunlight from entering a room during cooling operation by using curtains or blinds.
- Make sure the area is well ventilated. Do NOT block any ventilation openings.
- Ventilate often. Extended use requires special attention to ventilation.
- Keep doors and windows closed. If the doors and windows remain open, air will flow out of your room causing a decrease in the cooling or heating effect.
- Be careful NOT to cool or heat too much. To save energy, keep the temperature setting at a moderate level.

7 Maintenance and service

- NEVER place objects near the air inlet or the air outlet of the unit. Doing so may cause a reduced heating/cooling effect or stop operation.
- Turn the breaker off when the unit is NOT used for longer periods of time. If the breaker is on, the unit consumes electricity. Before restarting the unit, turn the breaker on 6 hours before operation to ensure smooth running.
- Condensation may form if the humidity is above 80% or if the drain outlet gets blocked.
- Adjust the room temperature properly for a comfortable environment. Avoid excessive heating or cooling. Notice that it may take some time for the room temperature to reach the set temperature. Consider using the timer setting options.
- Adjust the air flow direction to avoid cool air from gathering on the floor or warm air against the ceiling. (Up during cooling or dry operation to the ceiling and down during heating operation.)
- Avoid direct air flow to room inhabitants.
- Operate the system within the recommended temperature range (26~28°C for cooling and 20~24°C for heating) to save energy.

7 Maintenance and service

7.1 Overview: Maintenance and service

The installer has to perform a yearly maintenance.

About the refrigerant

This product contains fluorinated greenhouse gases. Do NOT vent gases into the atmosphere.

Refrigerant type: R32

Global warming potential (GWP) value: 675

NOTICE

Applicable legislation on **fluorinated greenhouse gases** requires that the refrigerant charge of the unit is indicated both in weight and CO₂ equivalent.

Formula to calculate the quantity in CO₂ equivalent tonnes: GWP value of the refrigerant × total refrigerant charge [in kg] / 1000

Please contact your installer for more information.

WARNING

The refrigerant inside the unit is mildly flammable, but normally does NOT leak. If the refrigerant leaks in the room and comes in contact with fire from a burner, a heater, or a cooker, this may result in fire, or the formation of a harmful gas.

Turn off any combustible heating devices, ventilate the room, and contact the dealer where you purchased the unit.

Do NOT use the unit until a service person confirms that the part from which the refrigerant leaked has been repaired.

WARNING

- Do NOT pierce or burn refrigerant cycle parts.
- Do NOT use cleaning materials or means to accelerate the defrosting process other than those recommended by the manufacturer.
- Be aware that the refrigerant inside the system is odourless.

WARNING

The appliance shall be stored in a room without continuously operating ignition sources (example: open flames, an operating gas appliance or an operating electric heater).

NOTICE

Maintenance MUST be done by an authorized installer or service agent.

We recommend performing maintenance at least once a year. However, applicable legislation might require shorter maintenance intervals.

DANGER: RISK OF ELECTROCUTION

To clean the air conditioner or air filter, be sure to stop operation and turn all power supplies off. Otherwise, an electric shock and injury may result.

WARNING

To prevent electrical shocks or fire:

- Do NOT rinse the unit.
- Do NOT operate the unit with wet hands.
- Do NOT place any objects containing water on the unit.

CAUTION

After a long use, check the unit stand and fitting for damage. If damaged, the unit may fall and result in injury.

CAUTION

Do NOT touch the heat exchanger fins. These fins are sharp and could result in cutting injuries.

Following symbols may occur on the indoor unit:

Symbol	Explanation
	Measure the voltage at the terminals of main circuit capacitors or electrical components before servicing.

7.2 To clean the indoor unit and user interface

WARNING

Improper detergents or cleaning procedure may cause damage on plastic components or water leakage. Splashed detergent on electric components, such as motors, may cause failure, smoke or ignition.

NOTICE

- Do NOT use gasoline, benzene, thinner, polishing powder or liquid insecticide. **Possible consequence:** Discoloration and deformation.
- Do NOT use water or air of 40°C or higher. **Possible consequence:** Discoloration and deformation.
- Do NOT use polishing compounds.
- Do NOT use a scrubbing brush. **Possible consequence:** The surface finishing peels off.
- As an end user, you may NEVER clean inside parts of the unit by yourself; this work must be performed by a qualified service person. Contact your dealer.

DANGER: RISK OF ELECTROCUTION

Before cleaning, be sure to stop the operation, turn the breaker off or pull out the supply cord. Otherwise, an electric shock and injury may result.

- 1 Clean with a soft cloth. If it is difficult to remove stains, use water or a neutral detergent.

7.3 To clean the front panel

WARNING

Do NOT let the indoor unit get wet. **Possible consequence:** Electric shock or fire.

NOTICE

- Do NOT use gasoline, benzene, thinner polishing powder or liquid insecticide. **Possible consequence:** Discoloration and deformation.
- Do NOT use water or air of 50°C or higher. **Possible consequence:** Discoloration and deformation.
- Do NOT scrub firmly when washing the blade with water. **Possible consequence:** The surface sealing peels off.

You can remove the front panel to clean it.

CAUTION

Be careful when opening and handling the front panel; sharp edge of the front panel may cause injury.

- 1 Slide both sliders in the direction of the arrows until they click.

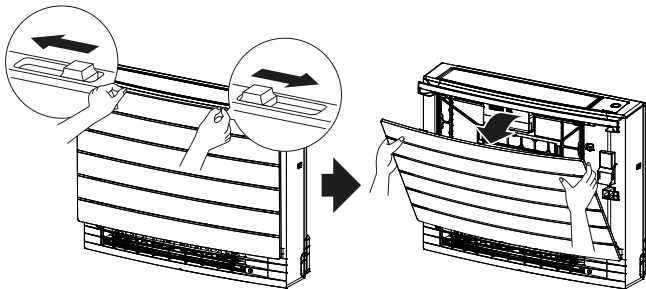

- 2 Open the front panel and undo the string.

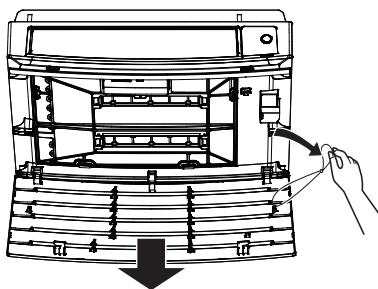

- 3 Remove the front panel.
- 4 Wipe it with a soft cloth soaked in water.
- 5 Let it dry in the shade after washing.
- 6 To reinstall and close the front panel, see "7.9 To re-install the front panel" [▶ 18].

7.4 To remove the filters

- 1 Remove the front panel. Refer to "7.3 To clean the front panel" [▶ 17].

- 2 Carefully remove the air filter tabs from the claws (a) on the sides. Hold the air filter by the filter knob (b) and unhook the air filter tab from the claw (c) on the top. Pull the filter up to remove the filter tabs from the claws on the bottom (d).

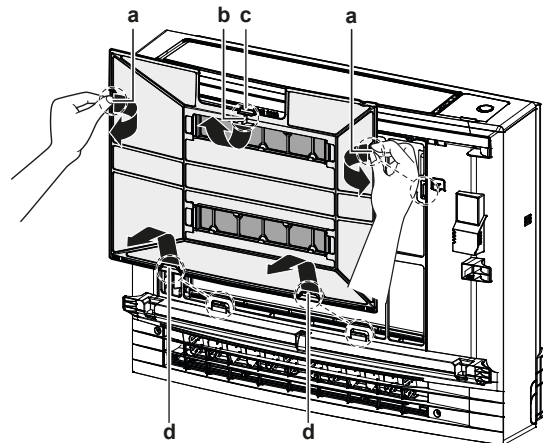

- a Tabs for claws on the side
- b Filter knob
- c Tab for the claw on the top
- d Tabs for claws on the bottom

- 3 Remove both titanium apatite deodorising filters from the claws (4 on each).

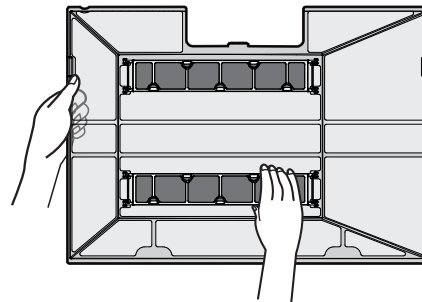

7.5 To clean the air filter

- 1 Wash the air filter with water or clean it with a vacuum cleaner.

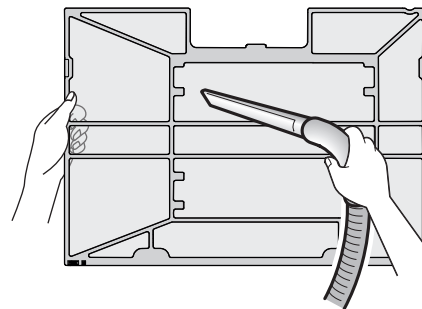

INFORMATION

- If the dust does NOT come off easily, wash them with a neutral detergent diluted in lukewarm water. Dry the air filters in the shade.
- It is recommended to clean the air filters every 2 weeks.

7.6 To clean the titanium apatite deodorising filter

INFORMATION

Clean the filter with water every 6 months.

- 1 Remove the dust from the filter with a vacuum cleaner.

8 Troubleshooting

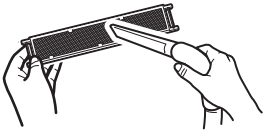

- 2 Soak the filter for 10 to 15 minutes in warm water. Do NOT remove the filter from the frame.

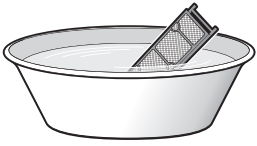

- 3 After washing, shake off remaining water and dry the filter in the shade. Do NOT wring out the filter when removing water.

7.7 To replace the titanium apatite deodorising filter

i INFORMATION

Replace the filter every 3 years.

- 1 Remove the filter from the tabs of the filter frame and replace the filter with a new one.

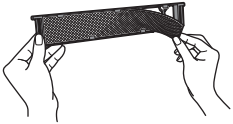

i INFORMATION

- Do NOT throw away the filter frame, but use it again.
- Dispose of the old filter as non-flammable waste.

7.8 To reinstall the filters

- 1 Hook both titanium apatite deodorising filters to the claws (4 on each).

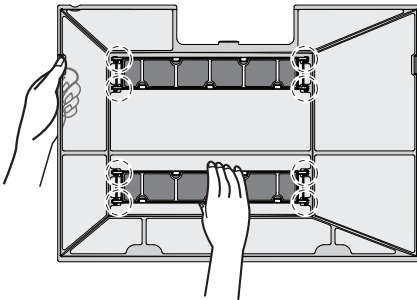

- 2 Insert the filter tabs to the claws on the bottom (d). Hold the air filter by the filter knob (b) and insert the air filter tab to the claw (c) on the top. Insert the air filter tabs to the claws (a) on the sides. Make sure the air filter is securely fixed in all positions.

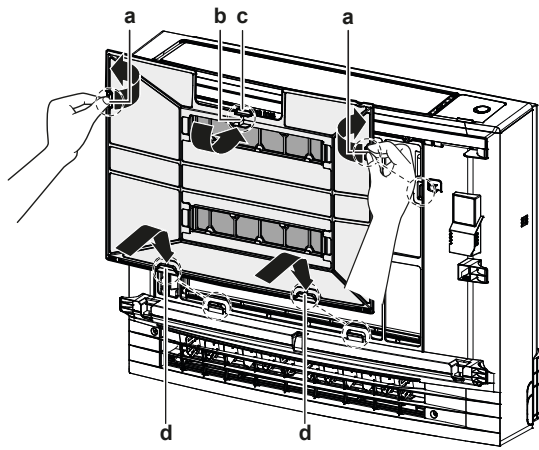

- a Tabs for claws on the side
- b Filter knob
- c Tab for the claw on the top
- d Tabs for claws on the bottom

7.9 To re-install the front panel

- 1 Insert the front panel into the grooves of the unit (3 places) and attach the string.

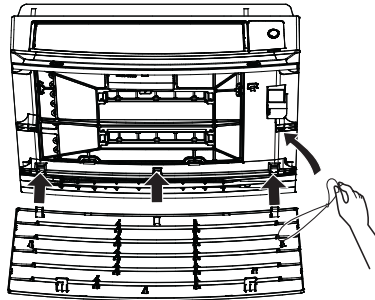

- 2 Close the front panel and slide both sliders until they click.

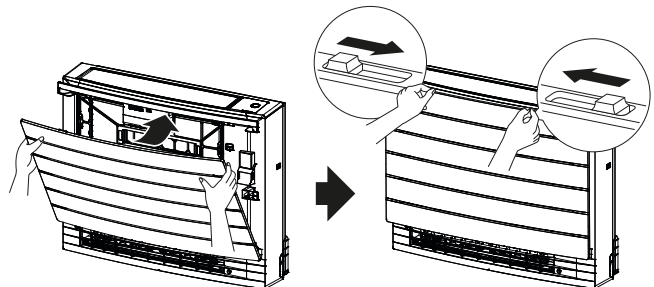

- 3 Push on the sides of the front panel to make sure the front panel is securely fixed.

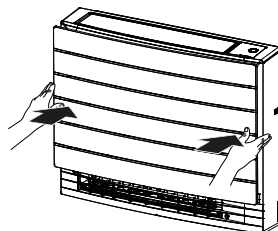

8 Troubleshooting

If one of the following malfunctions occur, take the measures shown below and contact your dealer.

**WARNING**

Stop operation and shut off the power if anything unusual occurs (burning smells etc.).

Leaving the unit running under such circumstances may cause breakage, electric shock or fire. Contact your dealer.

The system **MUST** be repaired by a qualified service person.

Malfunction	Measure
If a safety device such as a fuse, a breaker or an earth leakage breaker frequently actuates or the ON/OFF switch does NOT properly work.	Turn OFF the main power switch.
If water leaks from the unit.	Stop the operation.
The operation switch does NOT work well.	Turn OFF the power supply.
The Daikin eye flashes and you can check the error code by the user interface. To display the error code see the user reference guide of the indoor unit.	Notify your installer and report the error code.

If the system does NOT operate properly except for the above mentioned cases and none of the above mentioned malfunctions is evident, investigate the system in accordance with the following procedures.

**INFORMATION**

Refer to the reference guide located on <http://www.daikineurope.com/support-and-manuals/product-information/> for more troubleshooting tips.

If after checking all above items, it is impossible to fix the problem yourself, contact your installer and state the symptoms, the complete model name of the unit (with manufacturing number if possible) and the installation date (possibly listed on the warranty card).

9 Disposal

**NOTICE**

Do NOT try to dismantle the system yourself: dismantling of the system, treatment of the refrigerant, oil and other parts **MUST** comply with applicable legislation. Units **MUST** be treated at a specialised treatment facility for reuse, recycling and recovery.

ERC



DAIKIN INDUSTRIES CZECH REPUBLIC s.r.o.
U Nové Hospody 1/1155, 301 00 Plzeň Skvrňany, Czech Republic

DAIKIN EUROPE N.V.
Zandvoordestraat 300, B-8400 Oostende, Belgium

Copyright 2020 Daikin

3P477071-2K 2020.10